

 400 x 100 x 20 cm

 315 kg

 hot-dip galvanized steel

 EN 12811

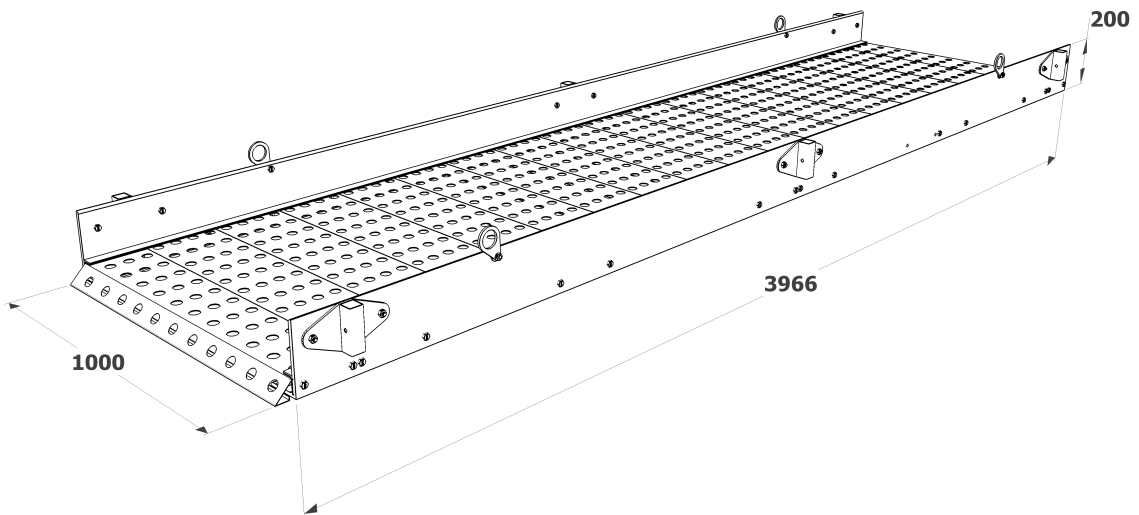
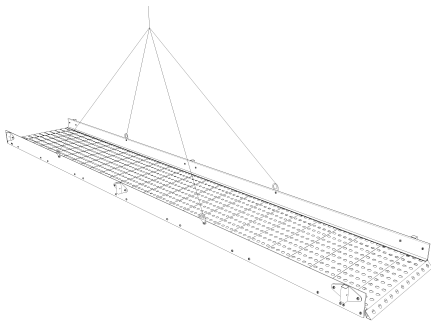
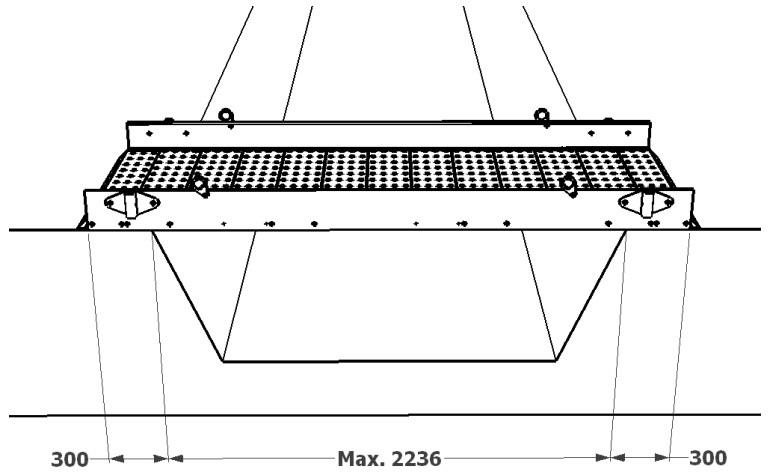

Tools: